



www.estesrockets.com

ESTES® INDUSTRIES  
1295 H Street  
Penrose, CO 81240  
PRINTED IN CHINA

# BABY BERTHA™

## FLYING MODEL ROCKET KIT INSTRUCTIONS

KEEP FOR FUTURE REFERENCE.

### EST 1261



### ASSEMBLY TIP

Read all instructions before beginning work on your model. Make sure you have all parts and supplies.

**TEST-FIT ALL PARTS TOGETHER BEFORE APPLYING ANY GLUE.** If any parts don't fit properly, sand as required for precision assembly.

### PARTS:

Locate the parts shown below and lay them out on the table in front of you. **DO NOT USE THIS DRAWING TO ASSEMBLE YOUR ROCKET.**

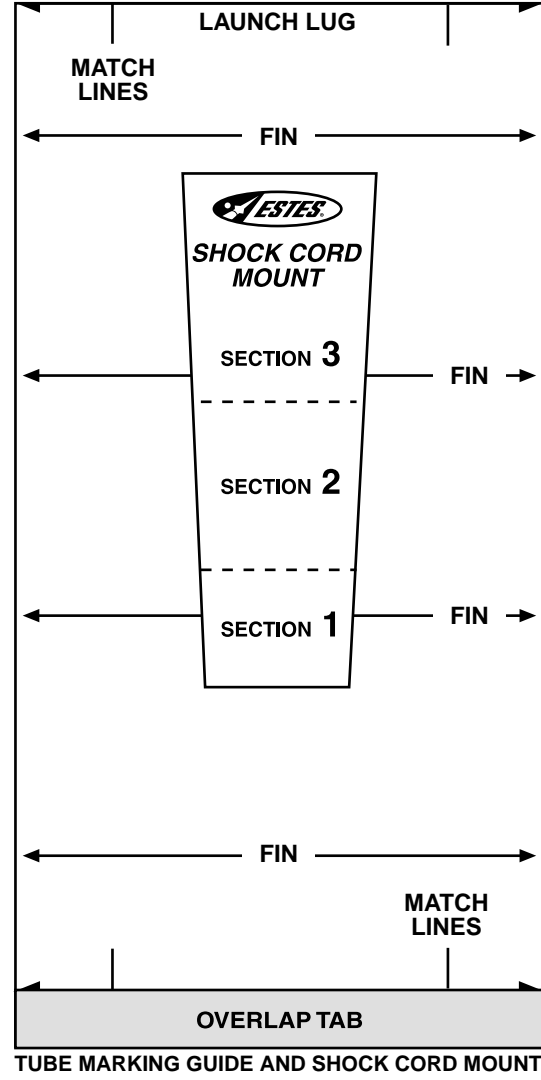

TUBE MARKING GUIDE AND SHOCK CORD MOUNT

HELPFUL HINT: IF NOSE CONE/COUPLER FIT IS...

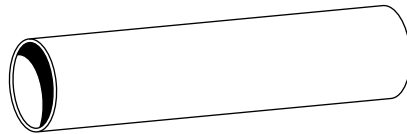
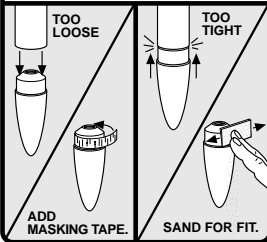

Body Tube BT-60 (1)  
(30400)

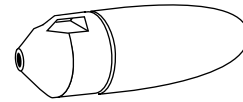

Nose Cone (1)  
(71020)



Launch Lug (1)  
(38175)



Mylar Retainer  
Ring (1)  
(30168)



Green Engine  
Block (1)  
(30162-2)



Shock Cord (1)  
(38374)



Engine Hook (1)  
(35021)

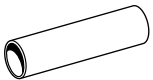

Blue Engine  
Mount Tube (1)  
(30326-1)

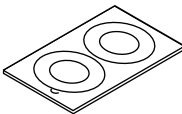

Centering Ring Card  
RA-2060 (1) (30128)



Decal Sheet (1)  
(37713)

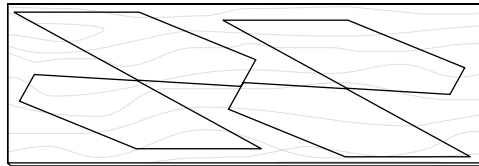

Die Cut Balsa Sheet (1)  
(32393)

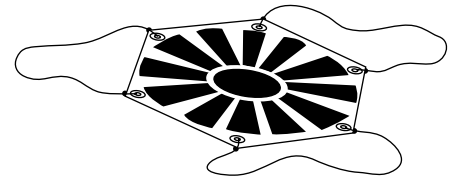

Assembled 12" (30 cm) Parachute  
(35801)

### SUPPLIES

In addition to the parts included in the kit you will also need:



SCISSORS



PENCIL



RULER



FINE SAND PAPER  
(#400-600 GRIT)



CARPENTER'S  
GLUE



MODELING  
KNIFE



MASKING  
TAPE



PRIMER  
(WHITE)



SPRAY PAINT:  
BLACK & WHITE



SPRAY CLEAR  
COAT  
(OPTIONAL)



1/32" (1 mm)  
WHITE  
PIN STRIPE TAPE

OR



WHITE PAINT  
PEN

# 1. ASSEMBLING ENGINE MOUNT

**A.** Measure and mark Engine Tube.

**B.** Cut 1/8" (3 mm) slit at 2 1/2" (64 mm) mark.

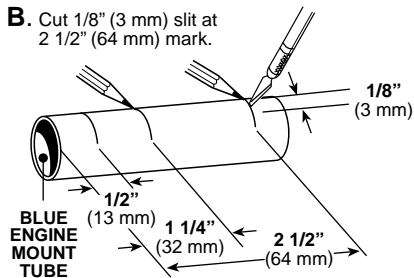

**E.** Apply glue inside front of Engine Mount Tube. Insert Green Engine Block.

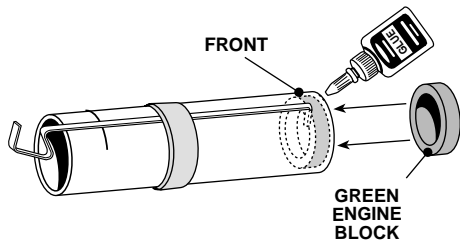

**C.** Apply glue around tube just ahead of the 1 1/4" (32 mm) mark. Position Hook.

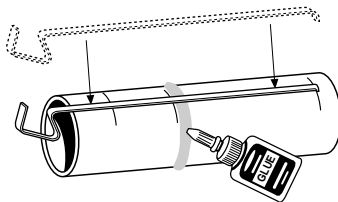

**F.** Apply glue around tube at 1/2" (13 mm) mark and slide notched Ring into place. Let glue set. Apply glue around end of tube and slide unnotched Centering Ring in place flush with tube end.

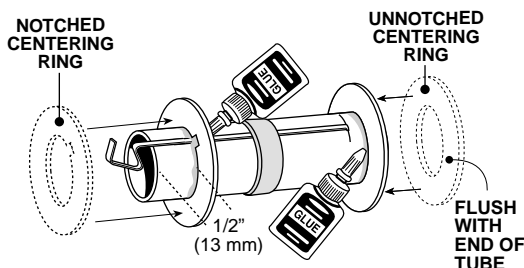

**D.** Slide Mylar Retainer Ring onto Engine Mount Tube up to 1 1/4" (32 mm) mark.

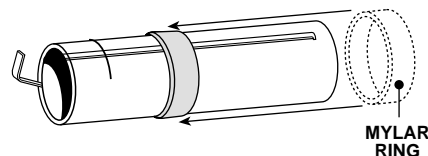

**G.** Apply glue fillets to both sides of Centering Rings. Let glue dry completely.

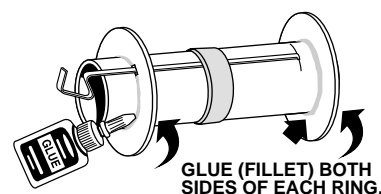

# 2. PREPARING FINS

**A.** Sand Die Cut Balsa Sheet with fine sandpaper.

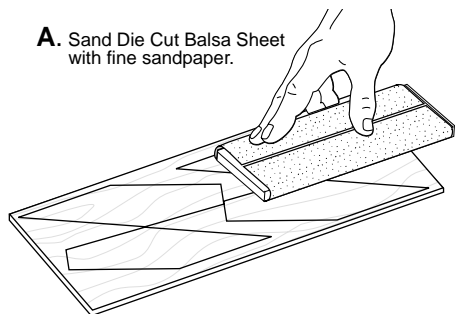

**B.** Cut Fins free with hobby knife.

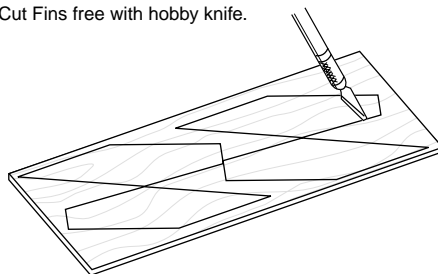

**C.** Stack Fins and sand edges.

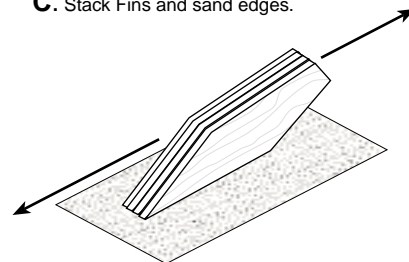

# 3. MARKING FIN AND LAUNCH LUG LINES

**A.** Cut out Tube Marking Guide from front page. Tape Tube Marking Guide around Body Tube. Mark Body Tube at arrows and Launch Lug line "LL".

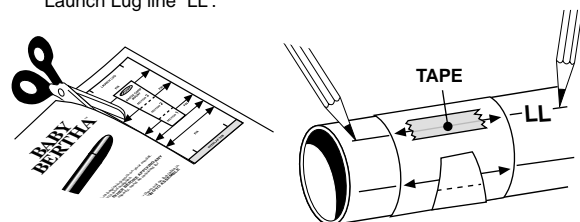

**B.** Remove the guide and save for step 6. Connect Fins and Launch Lug lines (arrows) using door frame as shown.

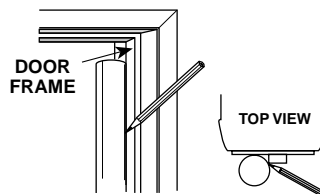

**C.** Extend Launch Lug line 3 3/4" (95 mm) from end of tube.

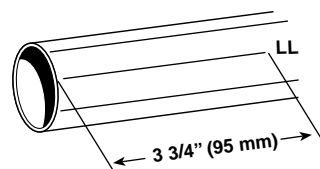

# 4. INSERTING ENGINE MOUNT

**A.** Use finger to smear glue 2" (51 mm) inside rear of Body Tube.

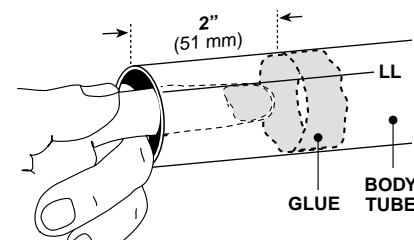

**B.** Align Engine Hook with Launch Lug line and insert Engine Mount until Engine Tube is even with Body Tube end.

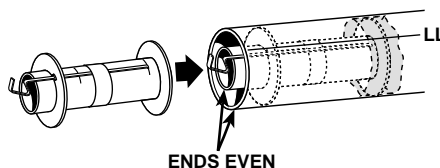

**C.** Use a scrap piece of balsa to apply a glue fillet to Centering Ring/Body Tube joint.

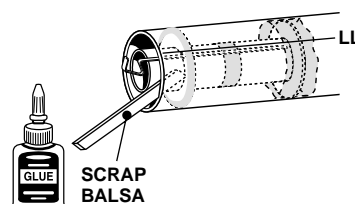

## 5. ATTACHING FINS

**A.** Apply thin layer of glue to edge of Fin, wait one minute. Apply second layer and attach Fin to Body Tube along one of the Fin lines. Repeat for remaining Fins.

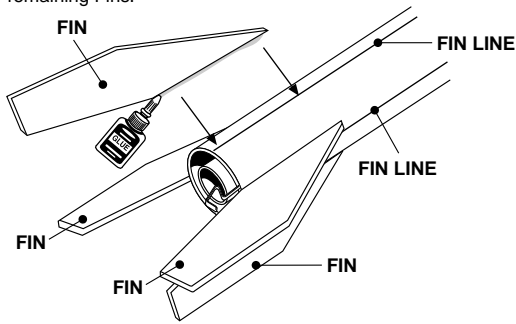

**B.** Check alignment of Fins as shown. Allow glue to set.

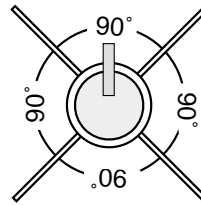

FINS SHOULD PROJECT STRAIGHT FROM THE BODY.

**C.** Stand rocket on flat table until glue dries completely.

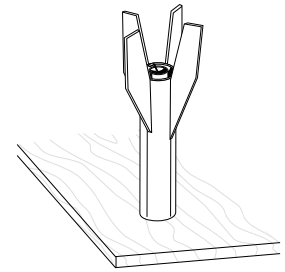

**NOTE:** FINS MUST BE ATTACHED CORRECTLY FOR A STABLE FLIGHT.

## 6. ATTACHING SHOCK CORD

**A.** Cut out Shock Cord Mount from Tube Marking Guide.

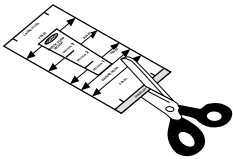

**B.** Apply glue. Fold forward.

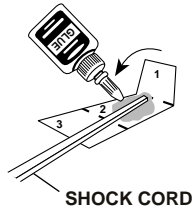

**C.** Apply glue. Fold forward.

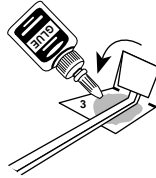

**D.** Squeeze tightly and hold for one minute.



**E.** Glue mount 1" (25 mm) inside Body Tube. Hold until glue sets. Let glue dry completely.

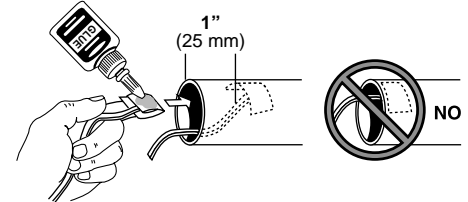

## 7. ATTACHING PARACHUTE & SHOCK CORD

**A.** Scrape excess flash from Nose Cone and clean the eyelet of the Nose Cone.

**CAUTION:** Do not cut off eyelet of Nose Cone.

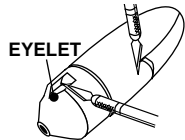

**B.**

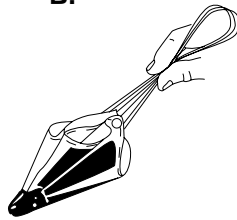

**C.**

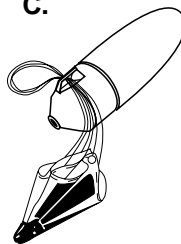

**D.**

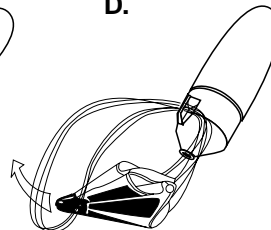

**E. DOUBLE KNOT**

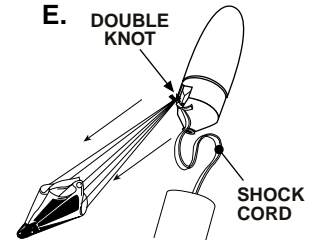

## 8. ATTACHING LAUNCH LUG

**A.** Glue Launch Lug centered onto "LL" line where shown.

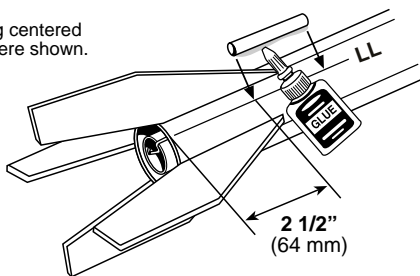

**B.** Apply glue fillets along Launch Lug and Fin/Body Tube joints, smoothing each fillet with your finger. Let glue dry completely.

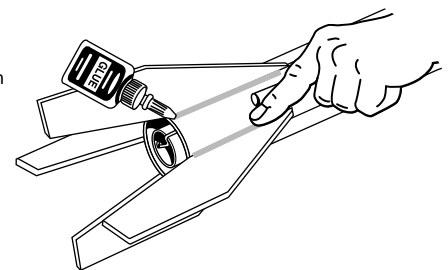

## PAINT SCHEME

First spray rocket with white primer, let dry and sand. Repeat until rocket is smooth. Follow the paint scheme on the front panel or design your own.

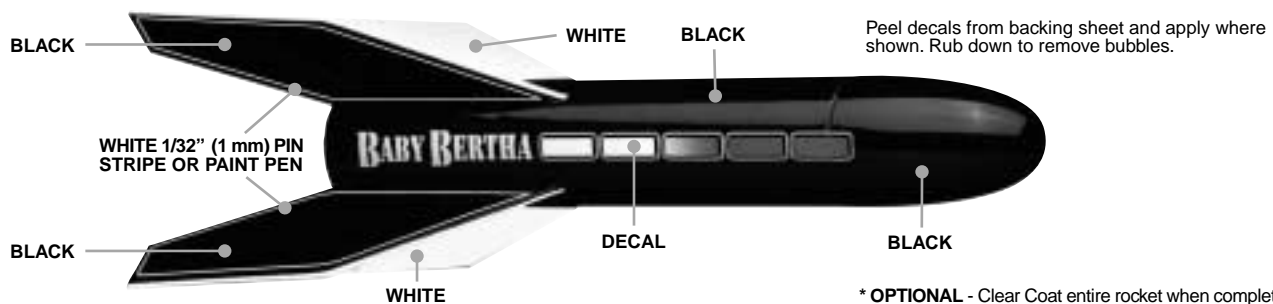

## ROCKET PREFLIGHT

**A.** Insert 3 or 4 loosely crumpled squares of Recovery Wadding.

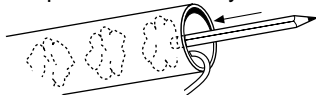

**B.** Spike.

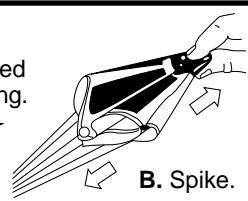

**C.** Fold.

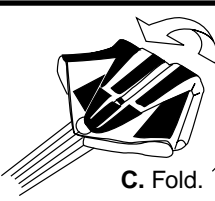

**D.** Roll.

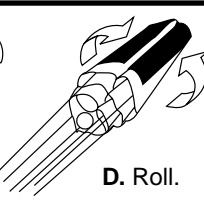

**E.** Wrap lines loosely, insert Parachute, Shock Cord and Nose Cone into Body Tube.

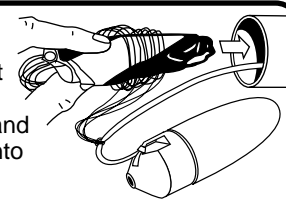

### WARNING: FLAMMABLE

To avoid serious injury, read instructions & NAR Safety Code included with engines.

**PREPARE YOUR ENGINE ONLY WHEN YOU ARE OUTSIDE AT THE LAUNCH SITE PREPARING TO LAUNCH!** If you do not use your prepared engine, remove the igniter before storing your engine.

**A.**

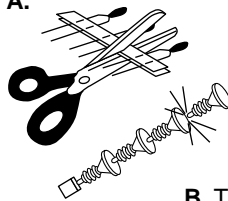

**B. TIP MUST TOUCH PROPELLANT.**

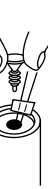
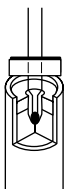

**C.**



**D.**



**E.**

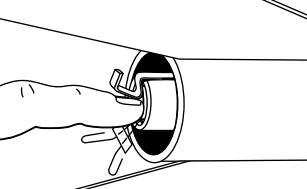

**F. Insert Engine into rocket.**

## COUNTDOWN AND LAUNCH

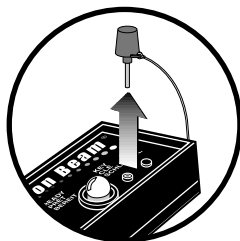

**KEY ALWAYS OUT UNTIL FINAL COUNTDOWN!**



**1...**

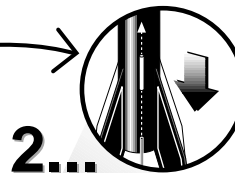

**2...**

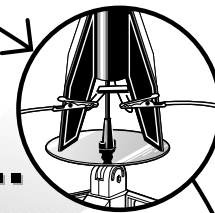

**3...**

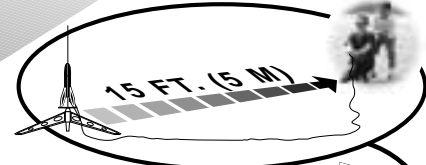

**4...**

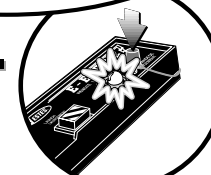

**INSERT KEY. PUSH DOWN AND HOLD.**



**5...**

**4... 3... 2... 1...**

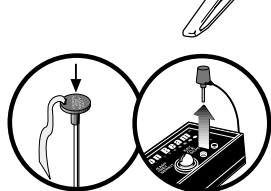

**LAUNCH BUTTON**

**HOLD KEY DOWN AND PRESS LAUNCH BUTTON UNTIL LIFT-OFF!**

## LAUNCH SUPPLIES

(sold separately):

- Porta-Pad® II Launch Pad
- Electron Beam® Launch Controller
- Recovery Wadding
- Igniters (w/ engines)
- Igniter Plugs (w/ engines)
- Recommended Estes Engines: A8-3, B4-4, B6-4, C6-5.

## PRECAUTIONS

NAR Safety Code

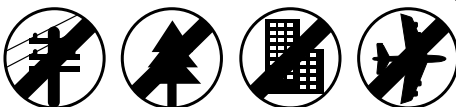

**NO DRY GRASS OR WEEDS**

## FLYING YOUR ROCKET

Choose a large field (250 ft. [76 m] square) free of dry weeds and brown grass. The larger the launch area, the better your chance of recovering your rocket. Football fields and playgrounds are great. Launch only with little or no wind and good visibility. Always follow the National Association of Rocketry (NAR) SAFETY CODE.

## MISFIRES

**TAKE THE KEY OUT OF THE CONTROLLER. WAIT ONE MINUTE BEFORE GOING NEAR THE ROCKET!** Take the plug and igniter out of the engine. If the igniter has burned, it worked but did not ignite the engine because it was not touching the propellant inside the engine. Put a new igniter all the way inside the engine without bending it. Push the plug in place. Repeat the steps under Countdown and Launch.